

WINTERLITE™

Privacy and sunlight control panels for PERGOLA COVERINGS

WINTERLITE SHOULD NOT BE WALKED ON!

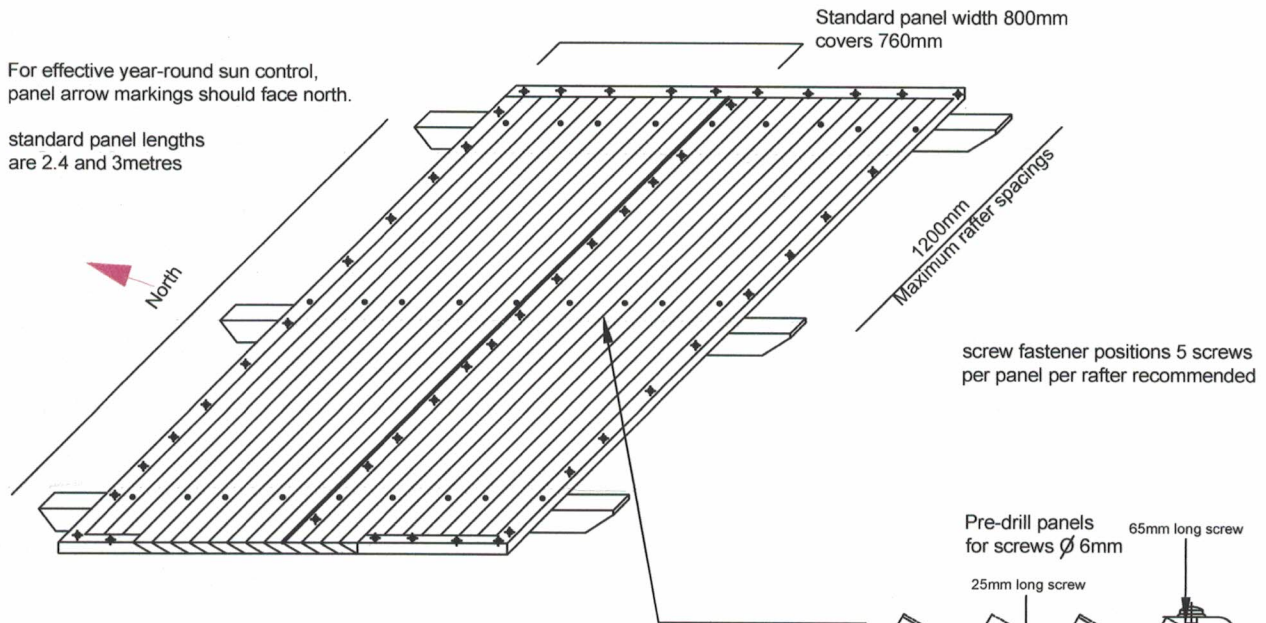

INSTALLATION GUIDE

Plan your material required on the back of the sheet

Install Winterlite panels using recommended fasteners and spacings. If panels need to be joined, refer to details below. Avoid panel end joints at mid span.

Fit edge capping and fasten to panels where indicated, ensuring it is fixed to posts where contact occurs.

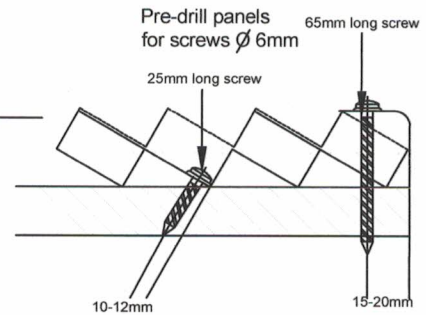

Fastener Legend

Screw	●	panel attachment to post
Rivet	◆	panel joints and capping fixings

Panel Side Joins

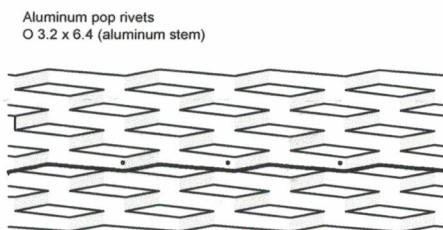

Panel End Joins

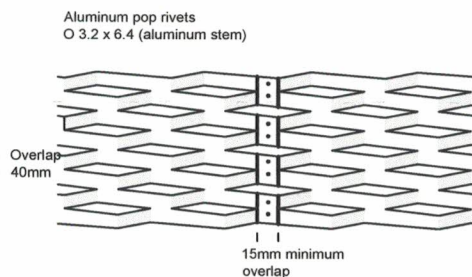

HOME PLUS

IMPROVEMENTS
454 PORT RD HINDMARSH, SA, 5007
PH: 8346 2222 FAX: 8346 2054
E/M: ADMIN@HOMEPPLUS.COM.AU

Plan your winterlitel PERGOLA COVERING here!

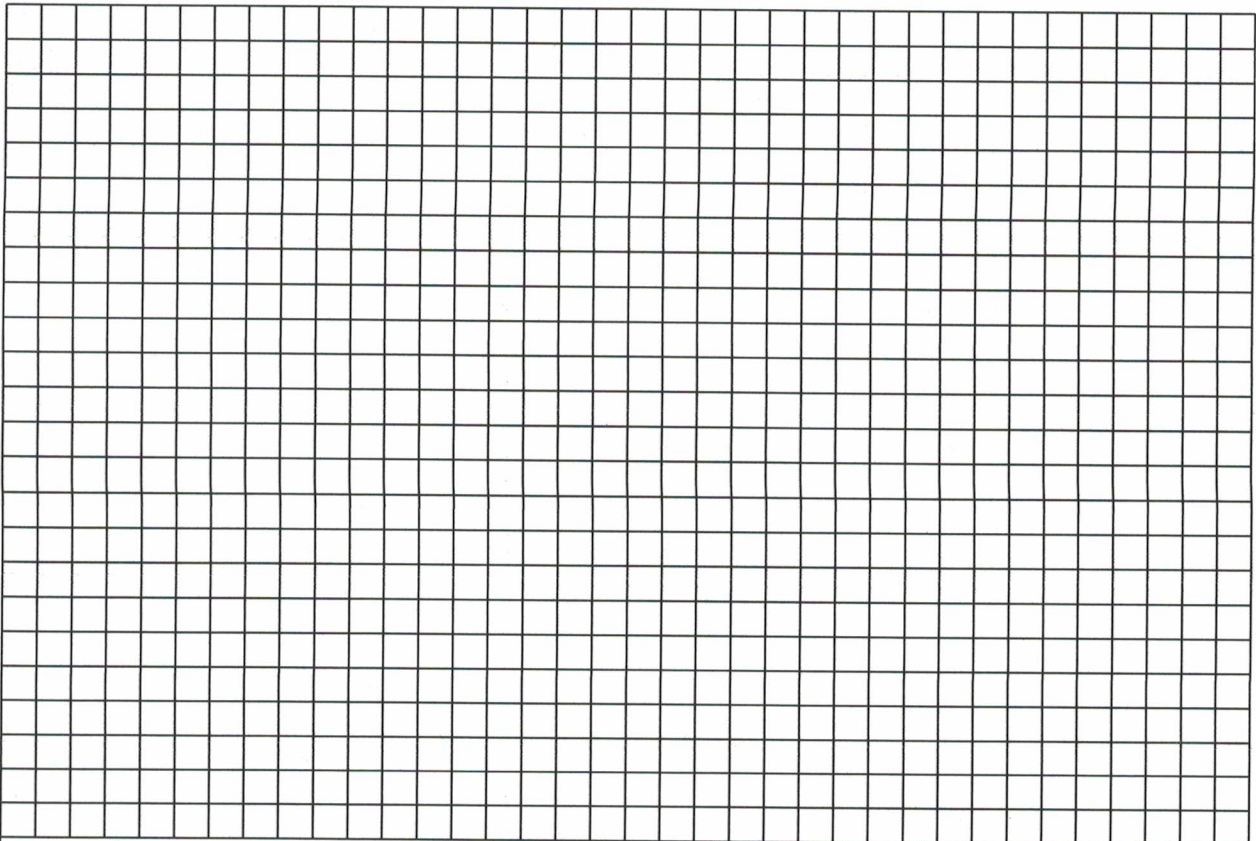

Points to consider:

1. sheet coverage:

no. of sheets	Coverage width	no. of sheets	Coverage width
1	0.8m	6	4.8m
2	1.56m	7	5.36m
3	2.32m	8	6.12m
4	3.08m	9	6.88m
5	3.84m	10	7.64m

- Sheet lengths - 2.4 & 3 metres.
- Check direction of north for sheet laying.
- Winterlite panels should not be walked on. It is a covering material - not a roofing structure.
- Add capping to finish the job.
- Winterlite panels are also suited to applications as a vertical screens. See separate sheet for information.

what to order

- Number of sheets required.
- Colour choice available.
- Capping required 3.25 & 6.5m lengths.
- Fasteners :
 - For timber posts - type 17 12- gauge hex HD gal. screws with neoprene seals.
 - For steel posts - Number 12 x 20 self-drilling 'teks' screws
 - Pop rivets - \varnothing 3.2 x 6.4 grip length aluminum rivet with aluminum stems.

* Type 17 screws require a driver socket for fixing.

Panel Cutting Detail

CAUTION ! cut edges can be sharp

Horizontal

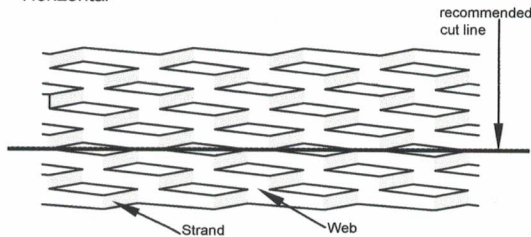

Vertical

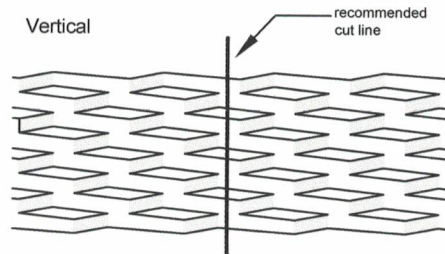

HOME PLUS

IMPROVEMENTS
454 PORT RD HINDMARSH, SA, 5007
PH: 8346 2222 FAX: 8346 2054
E/M: ADMIN@HOMEPLUS.COM.AU